

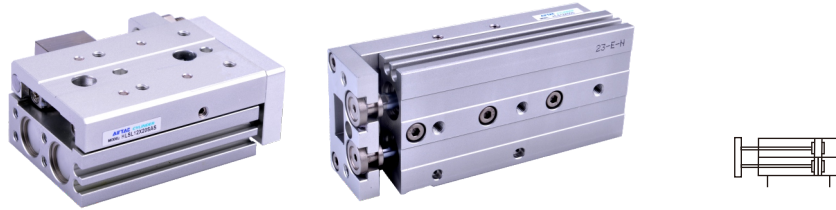

Slide table cylinder—HLS Series

Cross bearing type

Bore size: $\Phi 6$, $\Phi 8$, $\Phi 12$, $\Phi 16$, $\Phi 20$, $\Phi 25$



Ordering code

HLS 20×30 S AS T

① ② ③ ④ ⑤ ⑥

① Model

HLS: Slide table cylinder
(Double acting type)
(Cross bearing type)

HLSL: Symmetrical Slide table cylinder
(Double acting type)
(Cross bearing type)

② Bore Size

6 8 12 16 20 25

④ Magnet

S: With magnet

⑥ Thread type [Note3]

T: NPT

[Note1] Consult us for non-standard stroke.

[Note2] B type, BS type, BF type are unavailable for bore size of $\Phi 6$.

[Note3] When the thread is standard, the code is blank.

③ Stroke [Note1]

Bore size (mm)	Standard stroke (mm)	Max.std stroke
6	10 20 30 40 50	50
8	10 20 30 40 50 75	75
12	10 20 30 40 50 75 100	100
16	10 20 30 40 50 75 100 125	125
20	10 20 30 40 50 75 100 125 150	150
25	10 20 30 40 50 75 100 125 150	150

⑤ Adjuster option [Note2]

Blank: Without adjuster(Basic type)

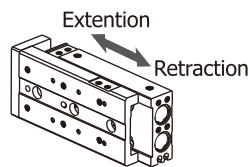

A: Adjustable rubber stopper (Both ends)

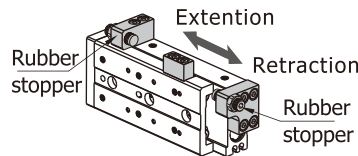

B: Shock absorber(Both ends)

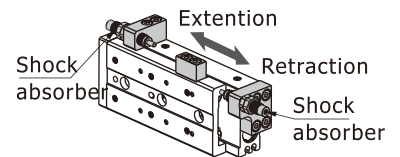

AS: Adjustable rubber stopper (Extension)

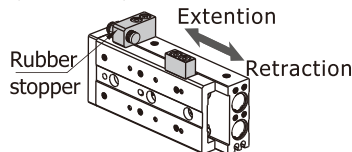

BS: Shock absorber(Extension)

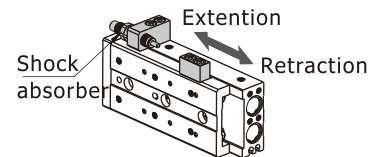

AF: Adjustable rubber stopper (Retraction)

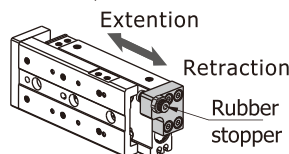

BF: Shock absorber(Retraction)

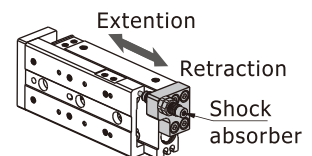

Slide tube cylinder



HLS, HLSSL Series

Cross bearing type
Bore size: Φ6, Φ8, Φ12, Φ16, Φ20, Φ25

Specification

Bore size(mm)	6	8	12	16	20	25
Acting type	Double acting					
Fluid	Air(to be filtered by 40μm filter element)					
Operating pressure	29~100psi(0.2~0.7MPa)			22~100psi(0.15~0.7MPa)		
Proof pressure	175psi(1.2MPa)					
Temperature	-20~70°C					
Speed range mm/s	50~500					
Stroke tolerance	Stroke≤100 ^{+1.0} ₀ Stroke>100 ^{+1.5} ₀					
Cushion type	Bumper(Both ends)、Shock absorber					
Sensor switches	CMSH、DMSH、EMSH					
Port size [Note1]	M5×0.8				1/8	

[Note1] NPT thread is available.

Criteria for selection: Cylinder thrust

Unit: Newton(N)

Bore size	Rod size	Acting type	Pressure area(mm ²)	Operating pressure(psi)						
				30	45	60	75	90	105	
6	3	Double acting	Push-side	42	8	13	17	21	25	29
			Pull-side	57	11	17	23	29	34	40
8	4	Double acting	Push-side	75	15	23	30	38	45	53
			Pull-side	101	20	30	40	51	61	71
12	6	Double acting	Push-side	170	34	51	68	85	102	119
			Pull-side	226	45	68	90	113	136	158
16	8	Double acting	Push-side	302	60	91	121	151	181	211
			Pull-side	402	80	121	161	201	241	281
20	10	Double acting	Push-side	471	94	141	188	236	283	330
			Pull-side	628	126	188	251	314	377	440
25	12	Double acting	Push-side	756	151	227	302	378	454	529
			Pull-side	982	186	295	393	491	589	687



Model Selection Method

Please select compact cylinder's type according to following procedure, and cross reference with data sheets.

A) Operating conditions(According to mounting position and work form)

1. Model used(Bore size, Stroke)
2. Type of cushion(Bumper, Shock absorber)
3. Mounting position of work(Top, front)
4. Mounting direction(Axial, Vertical)
5. Average speed V_a (mm/s)
6. Applied load W (N) **Fig. 1**
7. Overhang L_1, L_2, L_3 (mm)

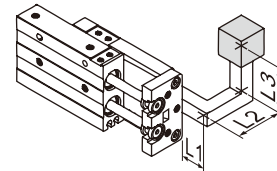

Explain: L_1 is the distance of load's center beyond the end plank's plane.
If load's center is not beyond the end plank's plane, L_1 is negative.

Fig. 1 : Applied load

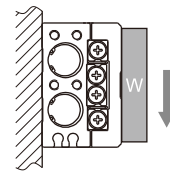
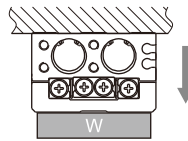
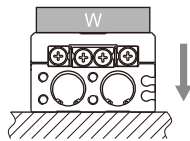

B) Kinetic energy check

1. Calculate kinetic energy of load E (J)

$$E = \frac{1}{2} \times \frac{W}{g} \times \frac{1.4 \times V_a^2}{1000}$$

2. Calculate allowable kinetic energy E_a (J)

$$E_a = K \times E_{max}$$

K : Mounting work coefficient (**Fig 2**)

E_{max} : Maximum allowable kinetic energy (**Table 1**)

3. Check that kinetic energy of load doesn't exceed allowable kinetic energy: $E \leq E_a$

C) Load check

1. Calculate allowable applied load W_a (N)

$$W_a = K \times \beta \times W_{max}$$

K : Mounting work coefficient (**Fig 2**)

W_{max} : Maximum allowable applied load (**Table 1**)

β : Applied load coefficient (**Fig 3**)

2. Check that load(W) doesn't exceed allowable applied load(W_a): $W \leq W_a$

Fig 2: Mounting work coefficient (K)

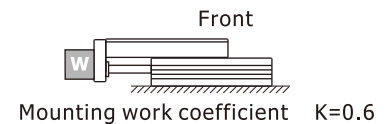
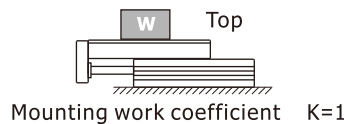
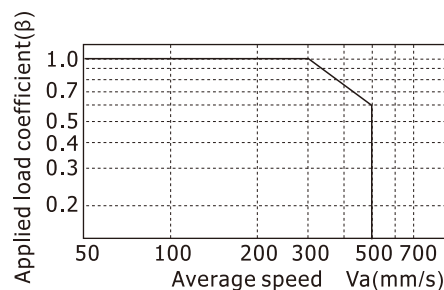
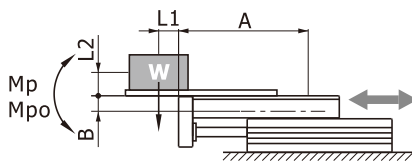

Fig 3: Applied load coefficient (β)



Horizontal

1. Calculate actual moment: M_p , M_{po} , M_y , M_{yo} , M_r , M_{ro} (Nm)



Dynamic moment :
 $M_p = W \times (L_1 + A) / 1000$

Static moment :
 $M_{po} = \frac{W \times (L_1 + A)}{1000} + \frac{W \times a \times (L_2 + B)}{1000 \times g}$

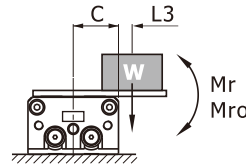

Dynamic moment :
 $M_r = W \times (C + L_3) / 1000$

Static moment :
 $M_{ro} = (W \times a \times (C + L_3)) / 1000g$

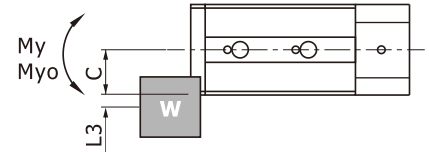

Dynamic moment :
 $M_y = 0$

Static moment :
 $M_{yo} = (W \times a \times (C + L_3)) / 1000g$

2. Check

Dynamic moment :	Static moment :
$\frac{M_p}{M_{p_{max}}} + \frac{M_y}{M_{y_{max}}} + \frac{M_r}{M_{r_{max}}} \leq 1$	$\frac{M_{po}}{M_{po_{max}}} + \frac{M_{yo}}{M_{yo_{max}}} + \frac{M_{ro}}{M_{ro_{max}}} \leq 1$

Vertical

1. Calculate actual moment: M_p , M_{po} , M_y , M_{yo} (Nm)

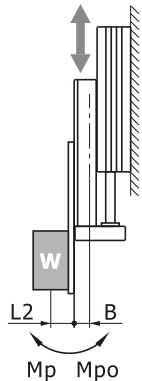

Dynamic moment :
 $M_p = W \times (L_2 + B) / 1000$

Static moment :
 $M_{po} = \frac{W \times (L_2 + B)}{1000} + \frac{W \times a \times (L_2 + B)}{1000 \times g}$

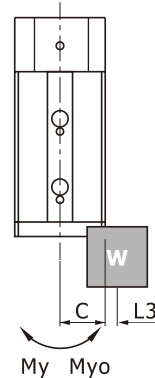

Dynamic moment :
 $M_y = W \times (C + L_3) / 1000$

Static moment :
 $M_{yo} = \frac{W \times a \times (C + L_3)}{1000g} + \frac{W \times (C + L_3)}{1000}$

2. Check

Dynamic moment :	Static moment :
$\frac{M_p}{M_{p_{max}}} + \frac{M_y}{M_{y_{max}}} \leq 1$	$\frac{M_{po}}{M_{po_{max}}} + \frac{M_{yo}}{M_{yo_{max}}} \leq 1$

Explain:

$L_1/L_2/L_3$: The distance of load center to mount plane (Determined by actuality).

$A/B/C$: Correction value for center position distance of moment (Refer to table 2).

$M_{p_{max}}/M_{y_{max}}/M_{r_{max}}/M_{po_{max}}/M_{yo_{max}}/M_{ro_{max}}$: Maximum allowable moment (Refer to table 2).

g : Acceleration of gravity ($g = 9.81 \text{ m/s}^2$).

a : Acceleration of inertia (Bumper: $a = 1600 \times (V_a/1000)^2$, Shock absorber: $a = 400 \times (V_a/1000)^2$)

W : Load weight (Determined by actuality).

Table 1 Maximum allowable kinetic energy (E_{max}) / Maximum allowable applied load (W_{max})

Model	Max. allowable kinetic energy E_{max} (J)			Max. allowable applied load W_{max} (N)
	Basic type	Rubber stopper type	Shock absorber type	
HLS6	0.01	0.01	-	4
HLS8	0.024	0.024	0.048	8
HLS12	0.05	0.05	0.1	15
HLS16	0.1	0.1	0.2	30
HLS20	0.13	0.13	0.26	40
HLS25	0.22	0.22	0.44	70

HLS, HLSSL Series

Cross bearing type
Bore size: Φ6, Φ8, Φ12, Φ16, Φ20, Φ25

Table 2 Maximum allowable moment(Nm),
Correction value for center position
distance of moment(mm)

Bore size	Stroke	Static moment			Dynamic moment			Correction value		
		M _{po} _{max}	M _{yo} _{max}	M _{ro} _{max}	M _p _{max}	M _y _{max}	M _r _{max}	A	B	C
6	10	3.3	3.8	2.6	0.7	0.7	0.6	27	7.3	16
	20	3.3	3.8	2.6	0.7	0.8	0.6	42		
	30	3.3	3.8	2.6	0.7	0.8	0.6	52		
	40	7.2	7.9	3.6	1.3	1.3	0.6	72		
	50	12.4	12.7	4.7	1.8	1.8	0.6	87		
8	10	10.1	9.1	8.8	2.5	2.5	2.0	32	8.5	20
	20	10.1	9.1	8.8	2.6	2.6	2.0	42		
	30	10.1	9.1	8.8	2.8	2.8	2.0	57		
	40	12.4	10.8	10.1	3.4	3.4	2.3	72		
	50	23.6	24.8	13.9	4.4	4.4	2.1	92		
12	75	32.8	35.3	16.4	4.6	4.6	1.8	132	10	25
	10	33.0	34.3	30.9	7.3	7.3	5.8	48		
	20	33.0	34.3	30.9	7.6	7.6	5.8	58		
	30	33.0	34.3	30.9	7.8	7.8	5.8	68		
	40	33.0	34.3	30.9	8.0	8.0	5.8	78		
16	50	53.4	49.6	39.7	9.8	9.8	5.8	88	11	30
	75	78.8	71.9	48.6	14.2	14.2	6.8	125		
	100	78.8	71.9	48.6	14.7	14.7	6.8	160		
	10	33.0	34.3	30.9	8.8	8.8	7.6	43		
	20	33.0	34.3	30.9	9.2	9.2	7.6	53		
20	30	33.0	34.3	30.9	9.5	9.5	7.6	63	16.5	35
	40	33.0	34.3	30.9	10.0	10.0	7.6	78		
	50	53.4	49.6	39.7	12.2	12.2	7.6	93		
	75	78.8	71.9	48.6	17.6	17.6	8.9	130		
	100	78.8	71.9	48.6	18.2	18.2	8.9	165		
25	125	143.7	144.5	53.3	24.8	24.8	7.8	204	20.3	42
	150	267.5	286.6	145.6	49.0	49.0	20.5	249		
	10	60.1	50.5	72.8	14.5	14.5	15.2	47		
	20	60.1	50.5	72.8	15.2	15.2	15.2	57		
	30	60.1	50.5	72.8	15.7	15.7	15.2	67		
25	40	60.1	50.5	72.8	16.3	16.3	15.2	82	20.3	42
	50	60.1	50.5	72.8	16.6	16.6	15.2	92		
	75	169.3	154.3	114.4	41.2	41.2	22.0	136		
	100	169.3	154.3	114.4	42.8	42.8	22.0	176		
	125	169.3	154.3	114.4	43.6	43.6	22.0	205		
25	150	267.5	286.6	145.6	65.0	65.0	28.3	254		
	10	60.1	50.5	72.8	16.3	16.3	17.6	52		
	20	60.1	50.5	72.8	17.0	17.0	17.6	62		
	30	60.1	50.5	72.8	17.4	17.4	17.6	72		
	40	60.1	50.5	72.8	17.8	17.8	17.6	82		
25	50	60.1	50.5	72.8	18.2	18.2	17.6	96	20.3	42
	75	169.3	154.3	114.4	45.2	45.2	25.3	141		
	100	169.3	154.3	114.4	46.2	46.2	25.3	165		
	125	169.3	154.3	114.4	48.0	48.0	25.3	210		
	150	267.5	286.6	145.6	65.0	65.0	28.3	254		

Note Symbol and unit

Symbol	Item	Unit
A B C	Correction value for center position distance of moment	mm
a	Acceleration of inertia	-
E	Kinetic energy	J
Ea	Allowable kinetic energy	J
E _{max}	Maximum allowable kinetic energy	J
g	Acceleration of gravity g=9.81	m/s ²
K	Mounting work coefficient	-
L1 L2 L3	Overhang	mm
M _p M _y M _r	Dynamic moment(Pitch,Yaw,Roll)	Nm
M _p _{max} M _y _{max} M _r _{max}	Maximum allowable dynamic moment (Pitch,Yaw,Roll)	Nm
M _{po} M _{yo} M _{ro}	Static moment(Pitch,Yaw,Roll)	Nm
M _{po} _{max} M _{yo} _{max} M _{ro} _{max}	Maximum allowable static moment (Pitch,Yaw,Roll)	Nm
Va	Average speed	mm/s
W	Applied load	N
W _{max}	Maximum allowable applied load	N
β	Applied load coefficient	-

Installation and application

1. How to mount cylinder :

1.1) Cylinder can to be mounted from 3 directions

Vertical Mounting(Body thread holes)

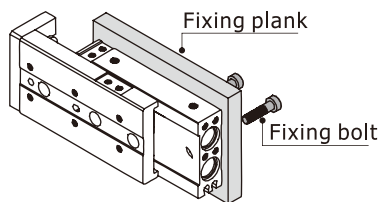

Axial Mounting(Body thread holes)

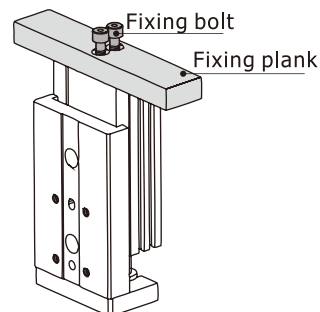

Vertical Mounting(Body through holes)

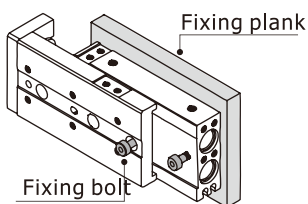

1.2) When mounting an compact slide cylinder, screws of appropriate length should be used and tightened properly within the maximum tightening torque. If screws are tightened beyond designed limits, malfunction may occur. If they are tightened insufficiently, it may result in sliding or falling off from its position.

Vertical Mounting(Body thread holes)

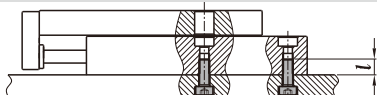

Model	Bolt used	Max. tightening torque (Nm)	Max. screw-in depth(mm)
HLS6	M4×0.7	2.1	8
HLS8	M4×0.7	2.1	8
HLS12	M5×0.8	4.4	10
HLS16	M6×1.0	4.4	10
HLS20	M6×1.0	7.4	12
HLS25	M8×1.25	18.0	16

Vertical Mounting(Body through holes)

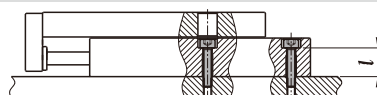

Model	Bolt used	Max. tightening torque (Nm)	Max. screw-in depth(mm)
HLS6	M3×0.5	1.2	11.0
HLS8	M3×0.5	1.2	12.5
HLS12	M4×0.7	2.8	18.0
HLS16	M5×0.8	5.7	25.0
HLS20	M5×0.8	5.7	28.0
HLS25	M6×1.0	10.0	36.2

Axial Mounting(Body thread holes)

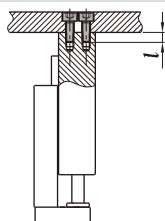

Model	Bolt used	Max. tightening torque (Nm)	Max. screw-in depth(mm)
HLS6	M2.5×0.45	0.5	3.5
HLS8	M3×0.5	0.9	4.0
HLS12	M4×0.7	2.1	6.0
HLS16	M5×0.8	4.4	7.0
HLS20	M5×0.8	4.4	8.0
HLS25	M6×1.0	7.4	10.0

2. Work Piece Mounting :

2.1) Work pieces can be mounted on 2 surfaces of the compact slide.

Front Mounting

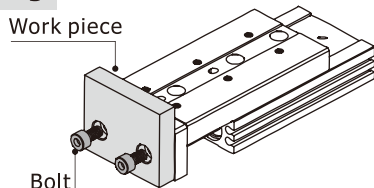

Top Mounting

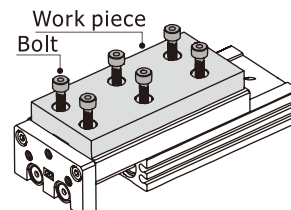

Slide table cylinder

HLS, HLSL Series

Cross bearing type Bore size: $\Phi 6$, $\Phi 8$, $\Phi 12$, $\Phi 16$, $\Phi 20$, $\Phi 25$

2.2) When mounting a work piece, tighten the bolts properly at a torque value within the limiting range. Use bolts at least 0.5mm shorter than maximum thread depth to prevent bolts from contacting the guide block. If the bolts are too long, they hit the guide block and cause damage.

Front Mounting

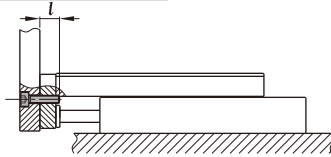

Model	Bolt used	Max. tightening torque (Nm)	Max. screw-in depth(mm)
HLS6	M3×0.4	0.9	5
HLS8	M4×0.7	2.1	6
HLS12	M5×0.8	4.4	8
HLS16	M6×1.0	7.4	10
HLS20	M6×1.0	7.4	13
HLS25	M8×1.25	18.0	15

Top Mounting

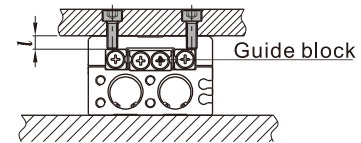

Model	Bolt used	Max. tightening torque (Nm)	Max. screw-in depth(mm)
HLS6	M3×0.5	0.9	4.0
HLS8	M3×0.5	0.9	5.0
HLS12	M4×0.7	2.1	5.5
HLS16	M5×0.8	4.4	6.0
HLS20	M5×0.8	4.4	10.0
HLS25	M6×1.0	7.4	13.0

2.3) Since the table is supported by the linear guide, take care not to apply strong impact or large moment to the guide section.

2.4) Hold the slide when fastening work pieces to it with bolts, If the body is held while tightening bolts, excessive moment may damage guide section.

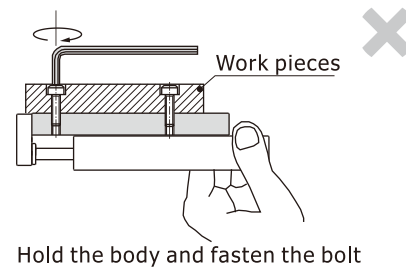
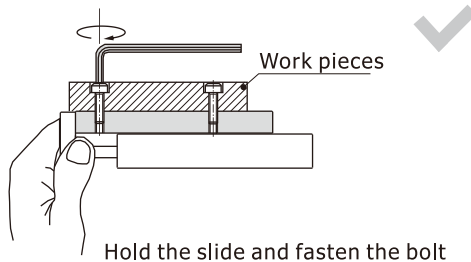

3. About shock absorber :

- 3.1) Shock absorbers are expendable. Promptly replace them when energy absorbing capacity decreases.
- 3.2) Never turn or adjust the screws on bottom of the shock absorber body. The screws are not for adjusting. Otherwise would cause oil leakage.
- 3.3) Follow the table for tightening torque of shock absorber to lock nuts.

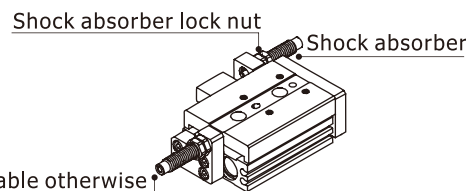

Model	Shock absorber	Tightening torque
HLS6	Without shock absorber	
HLS8	ACA0806-1N	1.67(Nm)
HLS12	ACA0806-1N	1.67(Nm)
HLS16	ACA1007-1N	3.14(Nm)
HLS20	ACA1210-1N	3.14(Nm)
HLS25	ACA1412-1N	10.8(Nm)

The screws are not adjustable otherwise would cause oil leakage.

4. How to mount sensor switch :

- 4.1) HLS Series are all with magnet. The matching sensor switches are DSH, DSHL series.
- 4.2) Maintain a minimum spacing of at least 3mm if two compact cylinders are used side by side in order to avoid malfunction.

5. Make sure to connect the compact cylinder to speed controller at the meter-out side, and the speed of compact cylinder must below 500mm/s.

6. Don't apply a load beyond the range of the operation limits. Different load or torque will cause different deflection to table, please see below for details.

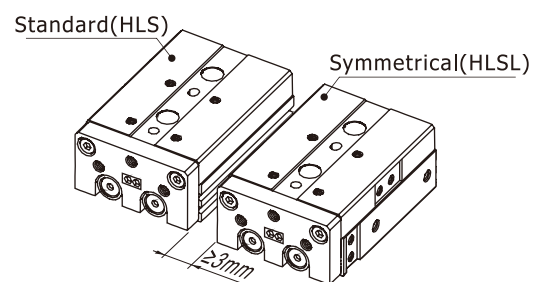

HLS, HLSL Series

Cross bearing type Bore size: $\Phi 6, \Phi 8, \Phi 12, \Phi 16, \Phi 20, \Phi 25$

6.1) Table deflection due to pitch moment:

Table deflection (arrow) when a load acts upon the section marked with the arrow at the full stroke of the compact slide.

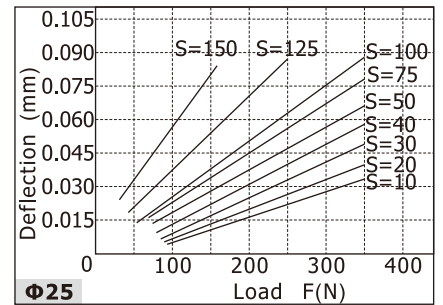
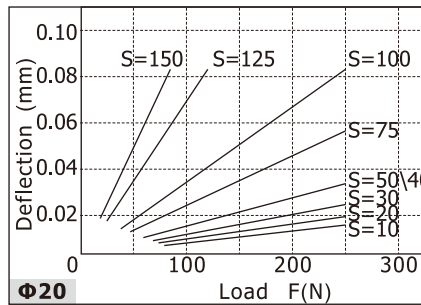
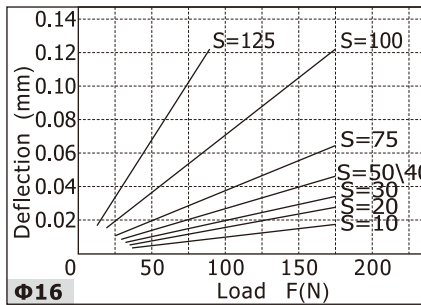
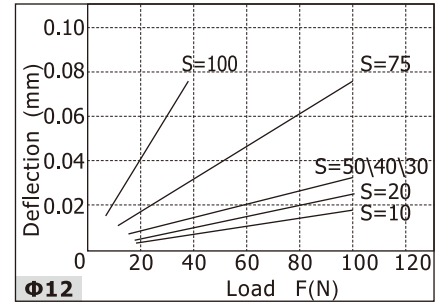
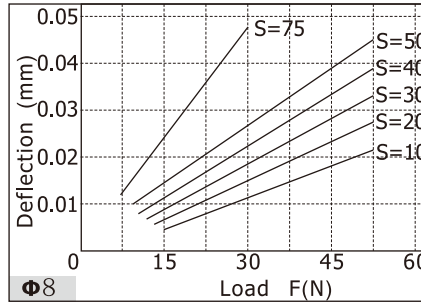
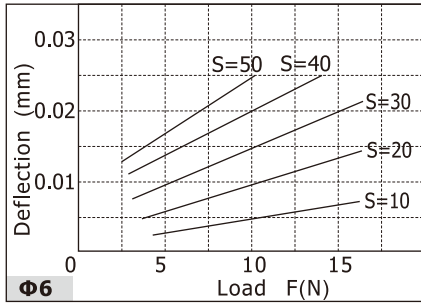

6.2) Table deflection due to yaw moment:

Table deflection (arrow) when a load acts upon the section marked with the arrow at the full stroke of the compact slide.

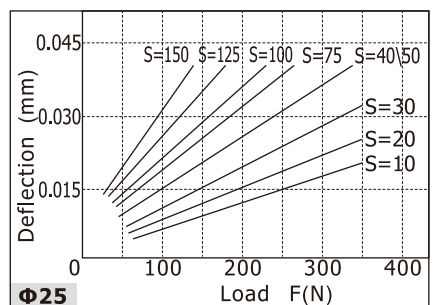
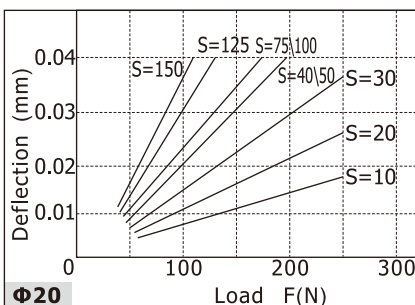
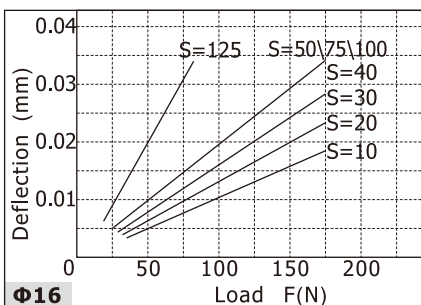
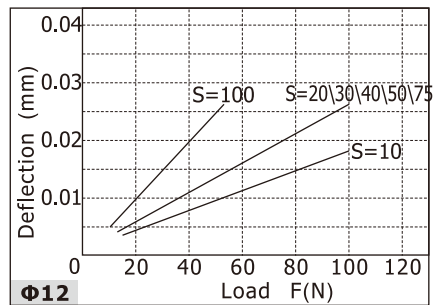
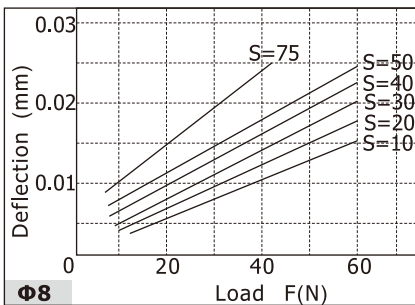
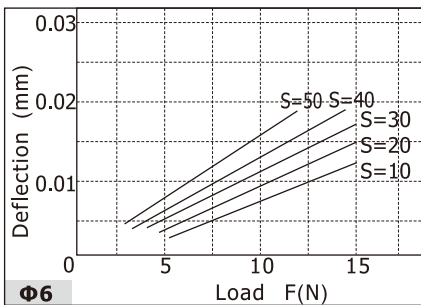
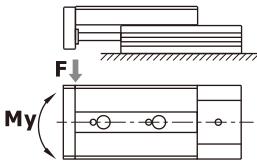

Slide tube cylinder

HLS, HLSL Series

Cross bearing type Bore size: $\Phi 6$, $\Phi 8$, $\Phi 12$, $\Phi 16$, $\Phi 20$, $\Phi 25$

6.3) Table deflection due to roll moment:

Table deflects (A) when a load acts upon section F at the full stroke of the compact slide.

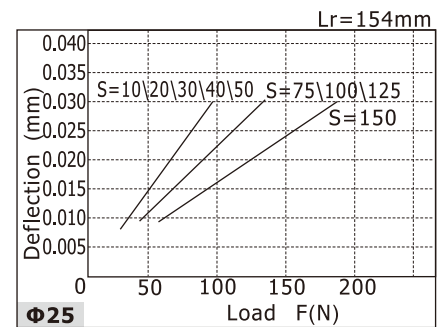
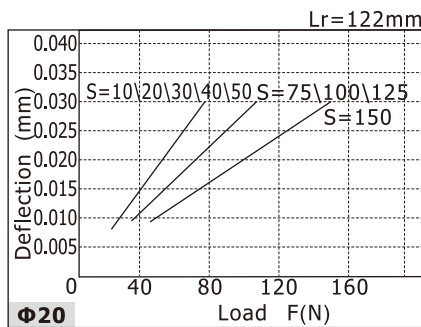
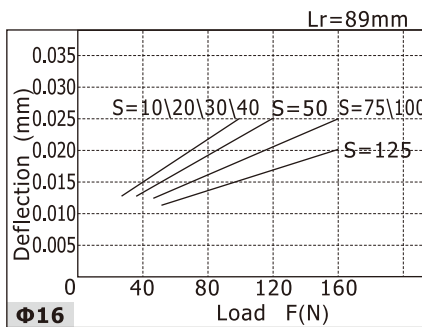
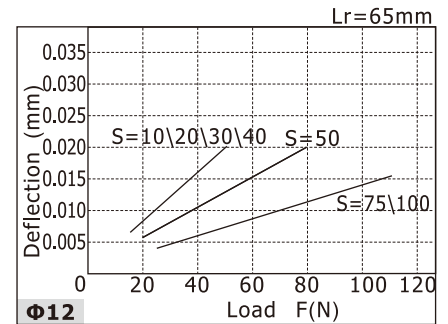
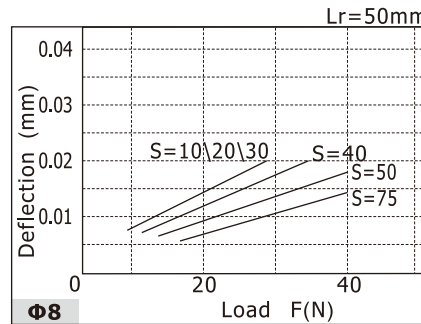
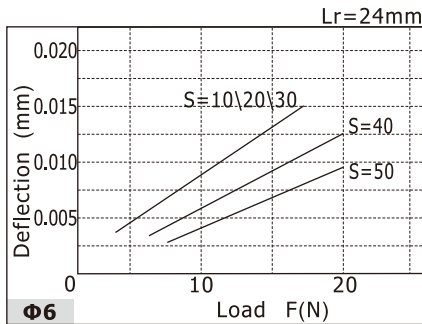
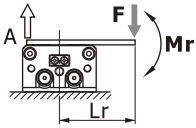

Inner structure

HLS

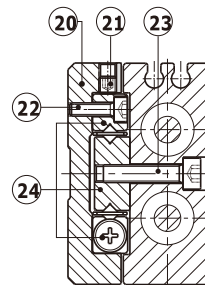
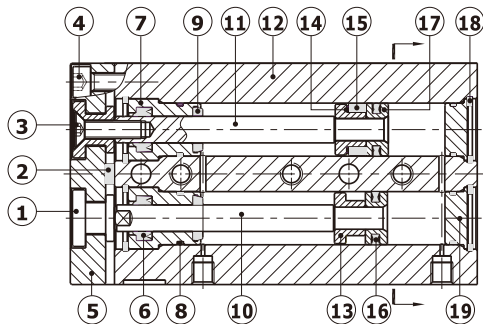

NO.	Item	NO.	Item
1	Floating joint	13	Magnet holder
2	Bumper	14	Magnet washer
3	Screw	15	Magnet
4	Screw	16	Piston seal
5	Fixing plate	17	Piston
6	Rod seal	18	C clip
7	Front cover	19	Back cover
8	O-ring	20	Slide table
9	Bumper	21	Nut
10	Piston rod A	22	Screw
11	Piston rod B	23	Screw
12	Body	24	Slide guide combination

Slide tube cylinder



HLS, HLSL Series

Cross bearing type

Bore size: $\Phi 6$, $\Phi 8$, $\Phi 12$, $\Phi 16$, $\Phi 20$, $\Phi 25$

HLSL6

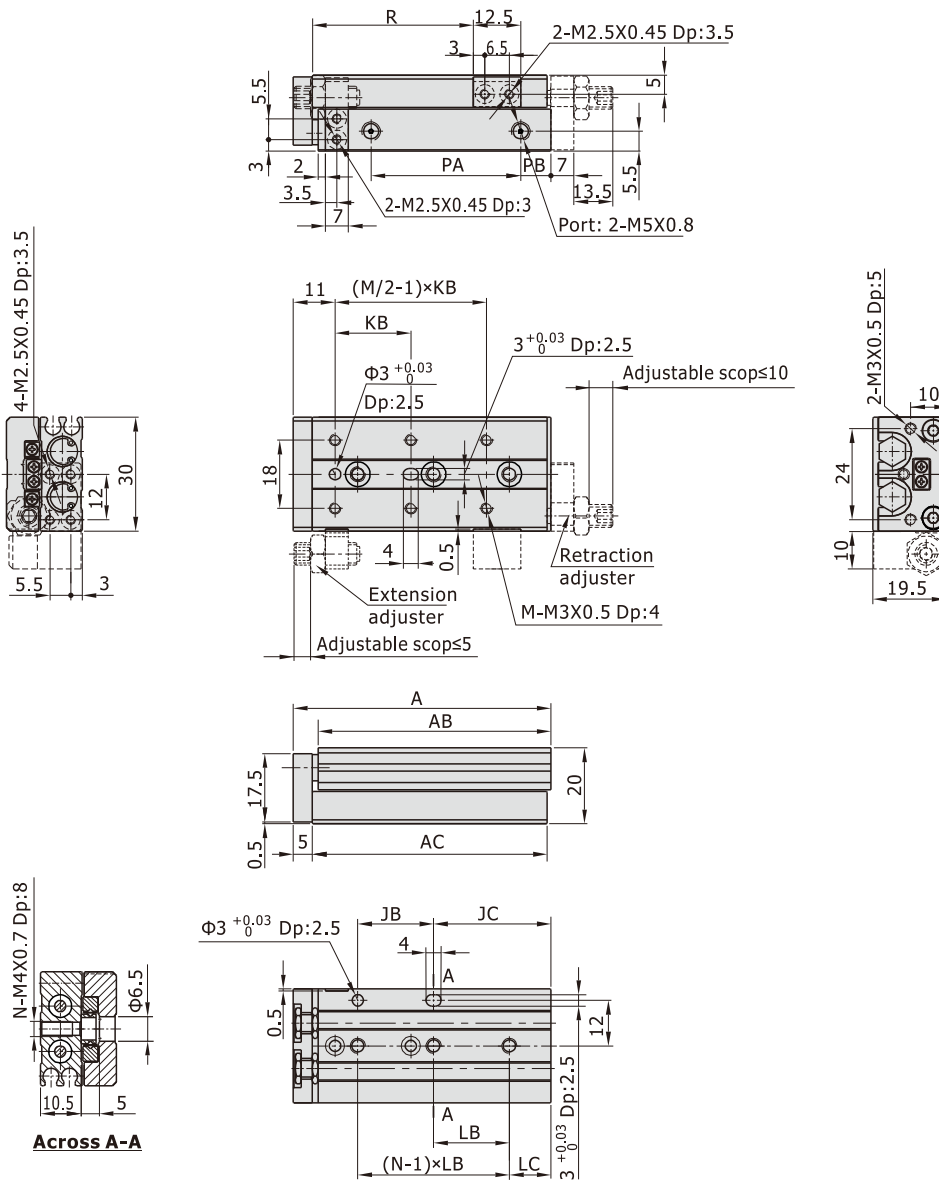

[Unit: mm]

Stroke/Item	A	AB	AC	JB	JC	KB	LB	LC	M	N	PA	PB	R
10	48	41.5	42	20	11	20	25	6	4	2	19	8	21.5
20	58	51.5	52	20	21	30	35	6	4	2	28	9	31.5
30	68	61.5	62	20	31	20	20	11	6	3	39	8	41.5
40	90	83.5	84	30	43	28	30	13	6	3	51	18	51.5
50	106	99.5	100	48	41	38	24	17	6	4	61	24	61.5



Slide tube cylinder



HLS, HLSL Series

Cross bearing type

Bore size: $\Phi 6$, $\Phi 8$, $\Phi 12$, $\Phi 16$, $\Phi 20$, $\Phi 25$

HLSL8

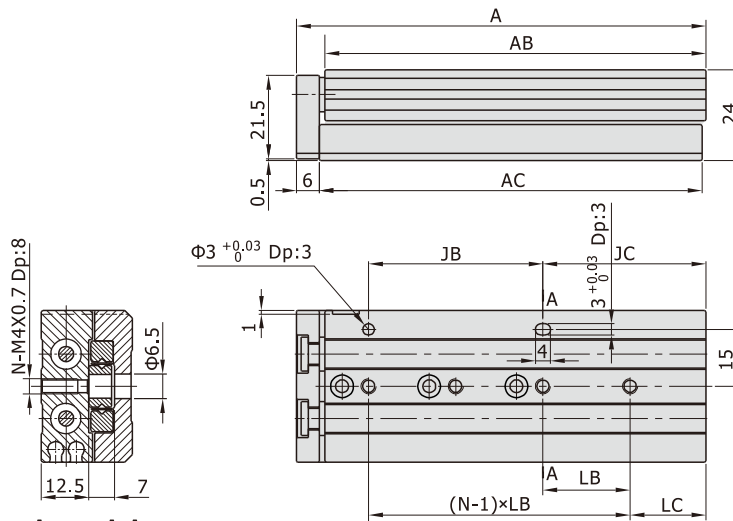
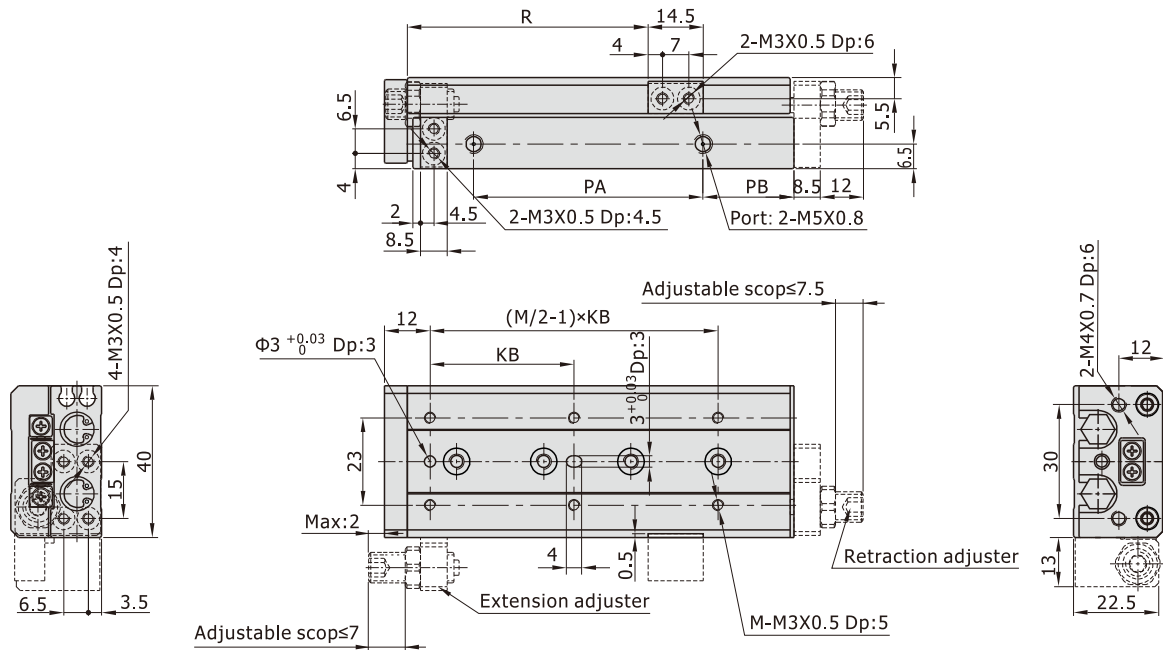

Across A-A

[Unit: mm]

Stroke\Item	A	AB	AC	JB	JC	KB	LB	LC	M	N	PA	PB	R
10	56	48.5	49	20	17	25	28	9	4	2	19.5	12.5	23.5
20	61	53.5	54	30	12	25	30	12	4	2	30	7	33.5
30	72	64.5	65	20	33	40	20	13	4	3	41	7	43.5
40	90	82.5	83	28	43	50	28	15	4	3	56	10	53.5
50	108	100.5	101	46	43	38	23	20	6	4	68	16	63.5
75	158	150.5	151	56	83	50	28	27	6	5	94	40	88.5

HLSL8(With shock absorber)

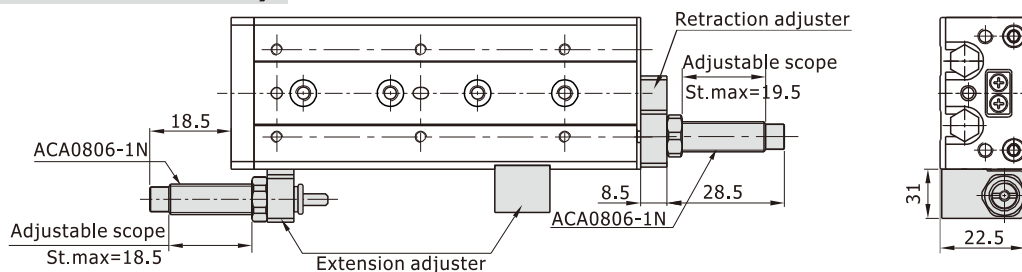

Slide tube cylinder

HLS, HLSL Series

Cross bearing type

Bore size: $\Phi 6$, $\Phi 8$, $\Phi 12$, $\Phi 16$, $\Phi 20$, $\Phi 25$

HLS12

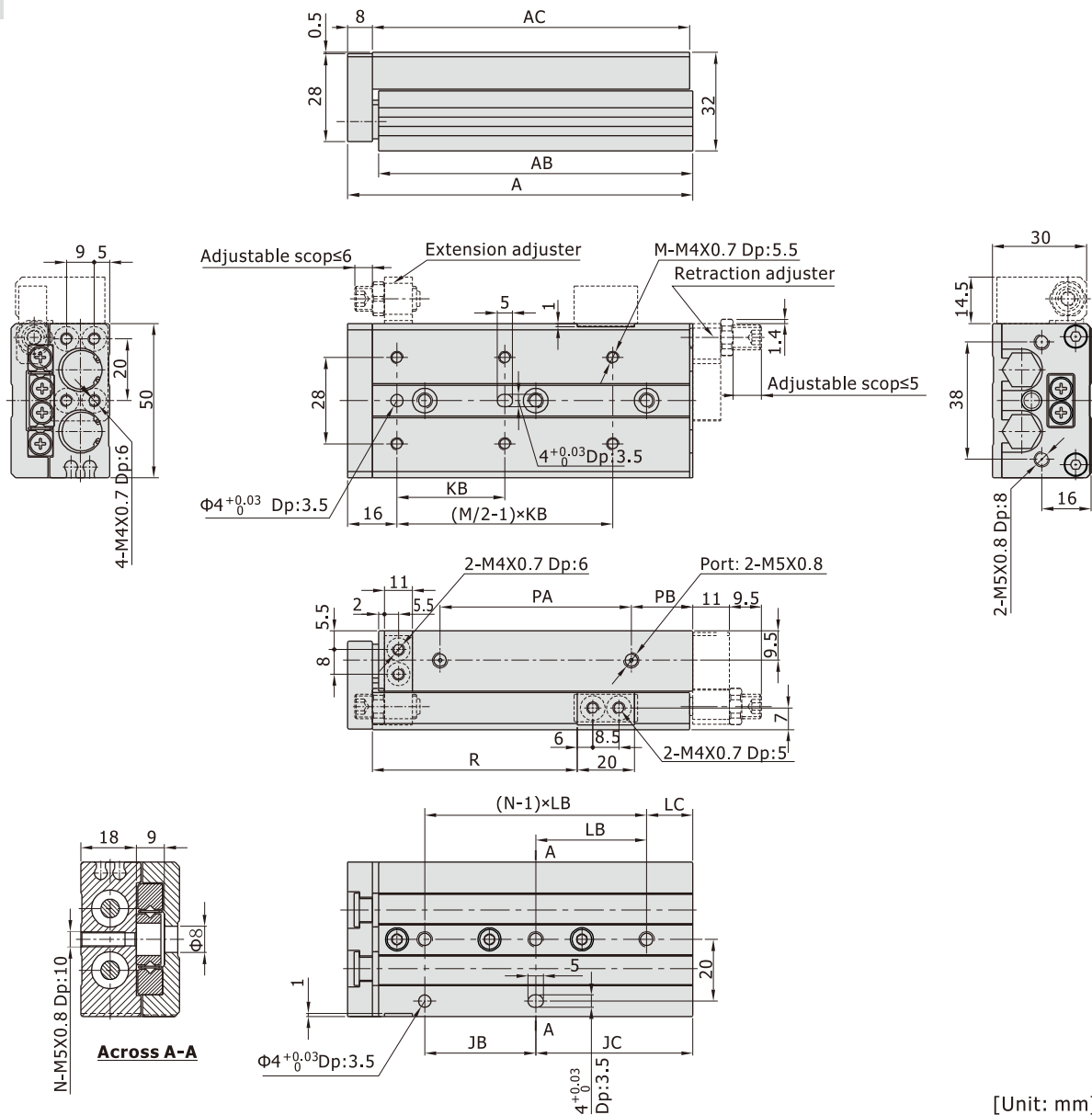

[Unit: mm]

Stroke/Item	A	AB	AC	JB	JC	KB	LB	LC	M	N	PA	PB	R
10	80	70	71	40	15	35	40	15	4	2	39.5	10	25
20	80	70	71	40	15	35	40	15	4	2	39.5	10	35
30	80	70	71	40	15	35	40	15	4	2	39.5	10	45
40	92	82	83	25	42	50	25	17	4	3	51.5	10	55
50	112	102	103	36	51	35	36	15	6	3	61.5	20	65
75	158	148	149	72	61	55	36	25	6	4	87.5	40	90
100	212	202	203	76	111	65	38	35	6	5	131.5	50	115

HLS12(With shock absorber)

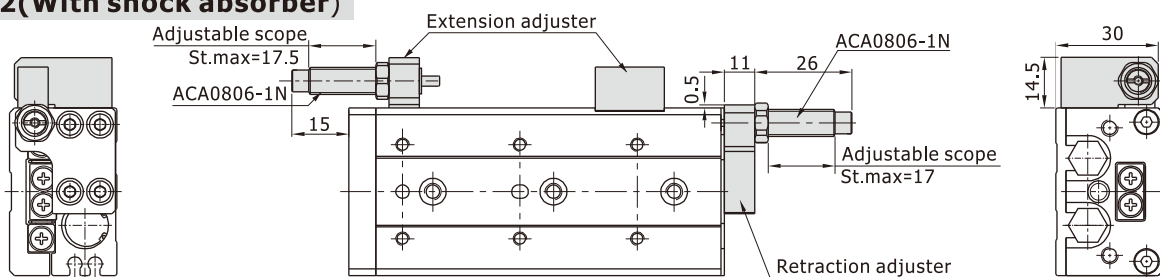

Slide tube cylinder



HLS, HLSL Series

Cross bearing type

Bore size: $\Phi 6$, $\Phi 8$, $\Phi 12$, $\Phi 16$, $\Phi 20$, $\Phi 25$

HLSL12

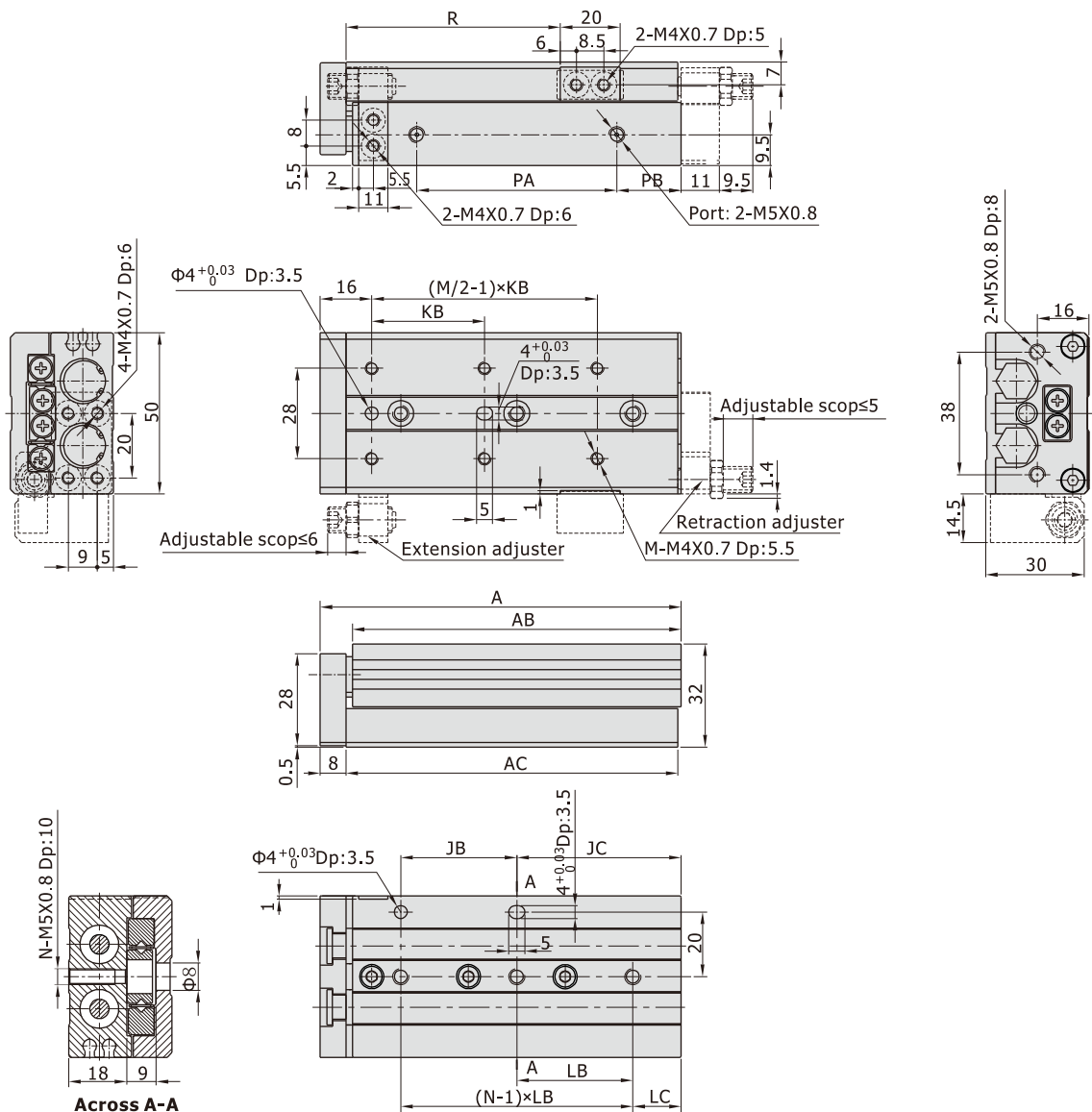

[Unit: mm]

Stroke/Item	A	AB	AC	JB	JC	KB	LB	LC	M	N	PA	PB	R
10	80	70	71	40	15	35	40	15	4	2	39.5	10	25
20	80	70	71	40	15	35	40	15	4	2	39.5	10	35
30	80	70	71	40	15	35	40	15	4	2	39.5	10	45
40	92	82	83	25	42	50	25	17	4	3	51.5	10	55
50	112	102	103	36	51	35	36	15	6	3	61.5	20	65
75	158	148	149	72	61	55	36	25	6	4	87.5	40	90
100	212	202	203	76	111	65	38	35	6	5	131.5	50	115

HLSL12(With shock absorber)

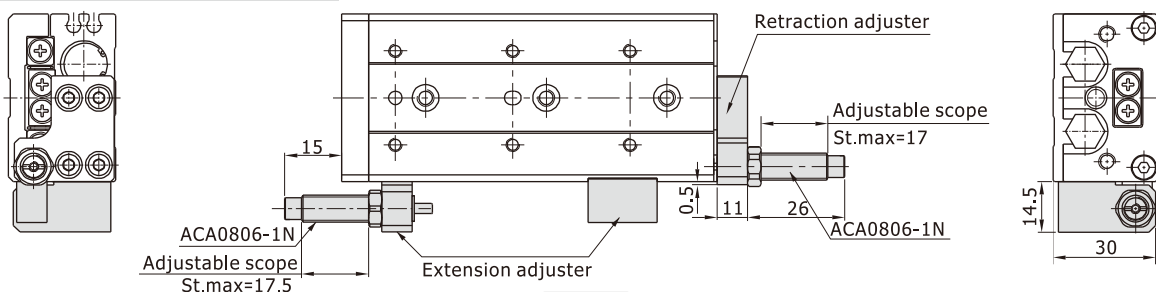

Slide tube cylinder

HLS, HLSL Series

Cross bearing type

Bore size: $\Phi 6$, $\Phi 8$, $\Phi 12$, $\Phi 16$, $\Phi 20$, $\Phi 25$

HLSL16

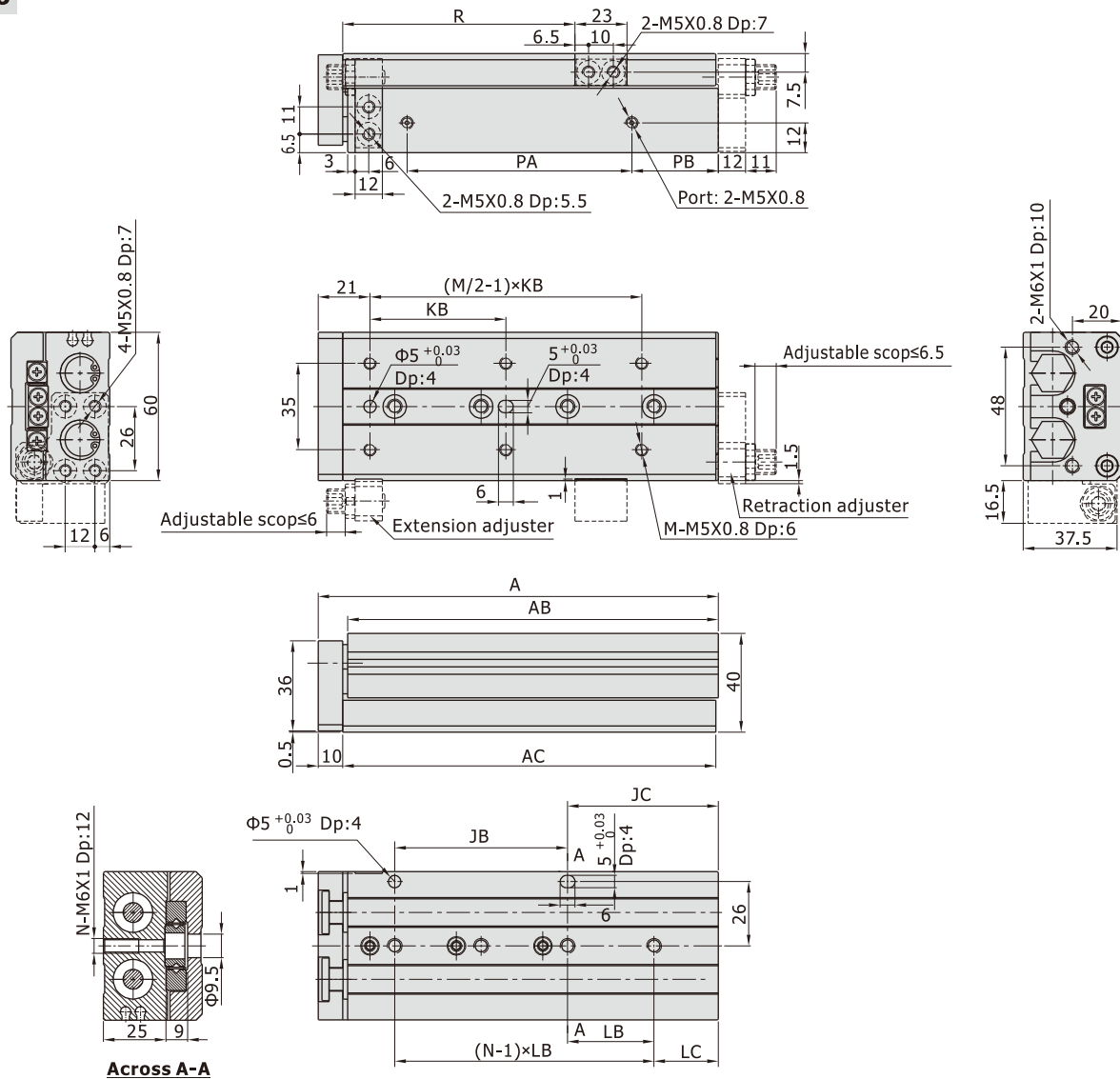

Across A-A

[Unit: mm]

Stroke\Item	A	AB	AC	JB	JC	KB	LB	LC	M	N	PA	PB	R
10	87	75	76	40	16	35	40	16	4	2	42.5	8	28.5
20	87	75	76	40	16	35	40	16	4	2	42.5	8	38.5
30	87	75	76	40	16	35	40	16	4	2	42.5	8	48.5
40	97	85	86	50	16	40	50	16	4	2	52.5	8	58.5
50	112	100	101	30	51	30	30	21	6	3	63.5	12	68.5
75	162	150	151	70	61	55	35	26	6	4	90.5	35	93.5
100	210	198	199	70	109	65	35	39	6	5	118.5	55	118.8
125	260	248	249	70	159	70	35	19	8	7	153.5	70	143.5

HLSL16(With shock absorber)

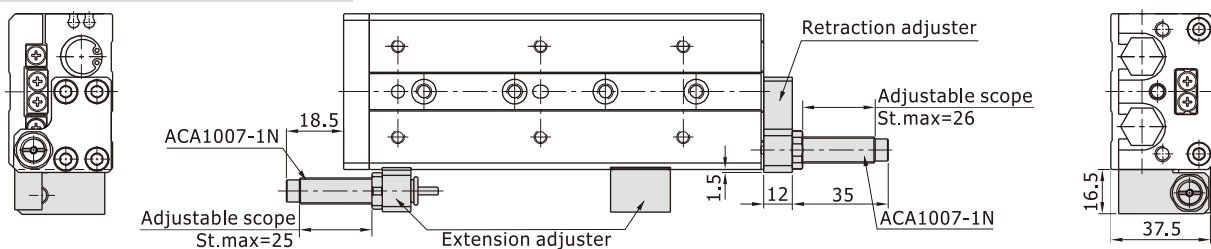

Slide tube cylinder

HLS, HLSL Series

Cross bearing type

Bore size: $\Phi 6$, $\Phi 8$, $\Phi 12$, $\Phi 16$, $\Phi 20$, $\Phi 25$

HLSL20

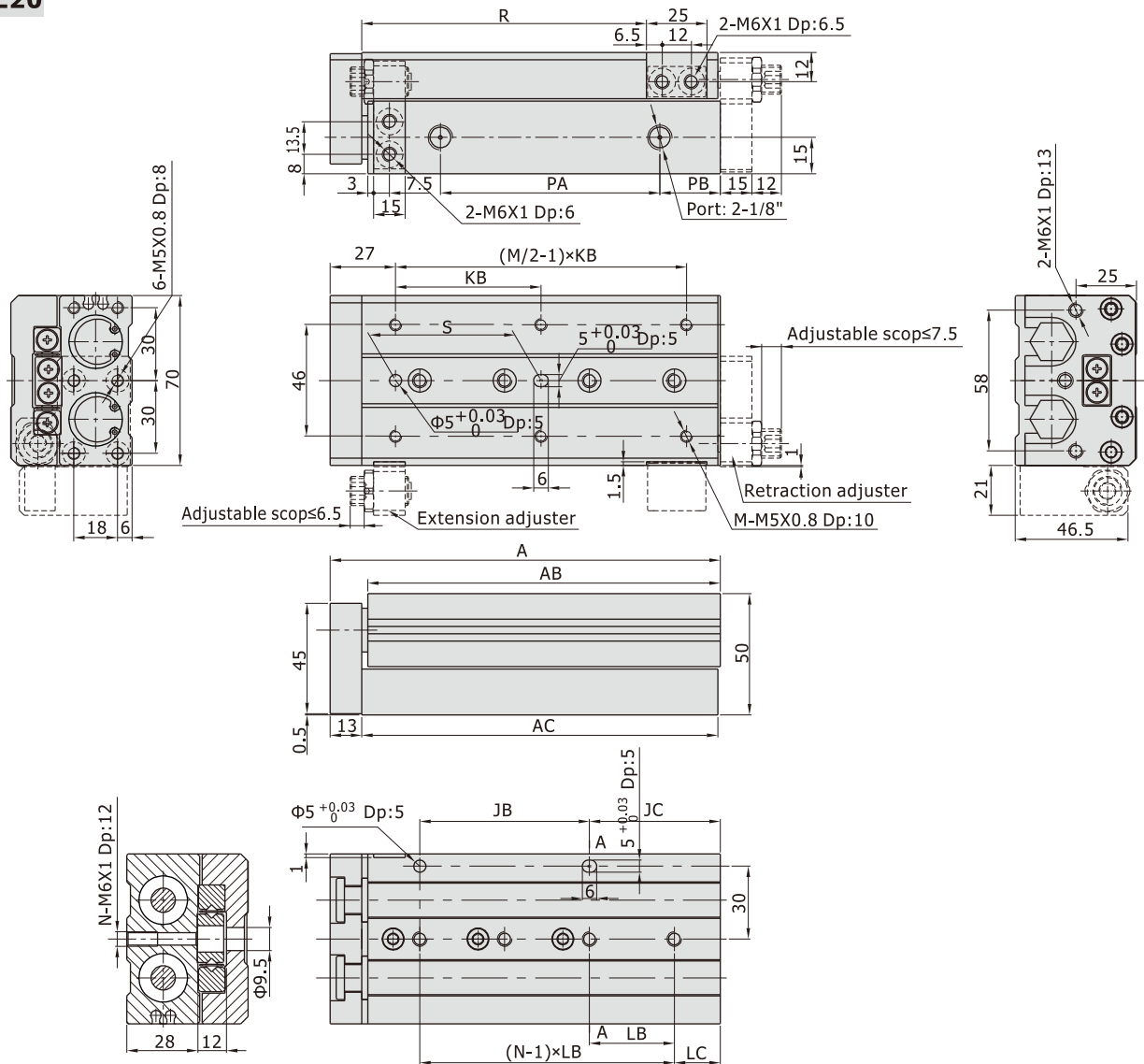

Across A-A

[Unit: mm]

Stroke\Item	A	AB	AC	JB	JC	KB	LB	LC	M	N	S	PA	PB	R
10	97	81.5	83	35	25	50	45	15	4	2	40	43.5	10	32.5
20	97	81.5	83	35	25	50	45	15	4	2	40	43.5	10	42.5
30	97	81.5	83	35	25	50	45	15	4	2	40	43.5	10	52.5
40	107	91.5	93	35	35	60	55	15	4	2	50	53.5	10	62.5
50	122	106.5	108	35	50	35	35	15	6	3	35	68.5	10	72.5
75	161	145.5	147	70	54	60	35	19	6	4	60	107.5	10	97.5
100	214	198.5	200	70	107	70	35	37	6	5	70	115.5	55	122.5
125	268	252.5	254	76	155	70	38	41	8	6	70	154.5	70	147.5
150	320	304.5	306	88	195	80	44	19	8	7	80	186.5	90	172.5

HLSL20(With shock absorber)

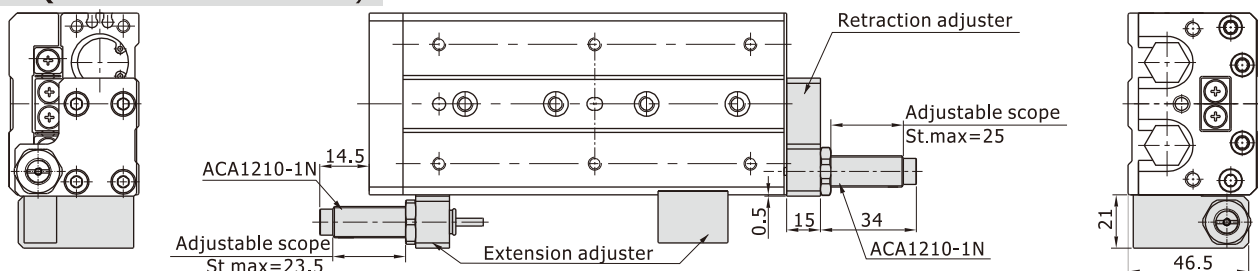

Slide tube cylinder



HLS, HLSL Series

Cross bearing type

Bore size: $\Phi 6, \Phi 8, \Phi 12, \Phi 16, \Phi 20, \Phi 25$

HLS25

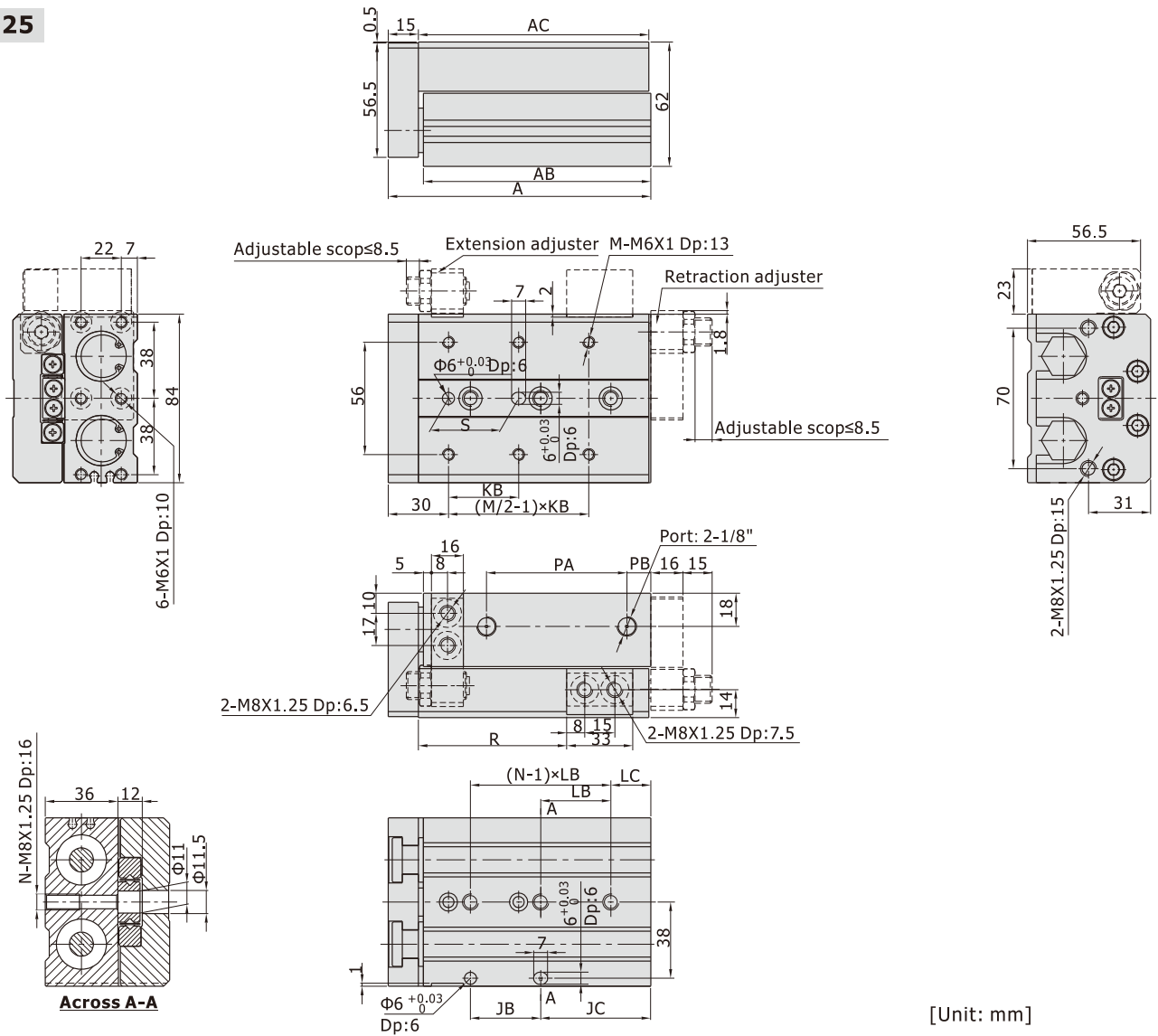

[Unit: mm]

Stroke/Item	A	AB	AC	JB	JC	KB	LB	LC	M	N	S	PA	PB	R
10	108	90.5	92	45	22	50	45	22	4	2	40	47	12	35
20	108	90.5	92	45	22	50	45	22	4	2	40	47	12	45
30	108	90.5	92	45	22	50	45	22	4	2	40	47	12	55
40	118	100.5	102	55	22	60	55	22	4	2	50	57	12	65
50	131	113.5	115	35	55	35	35	20	6	3	35	70	12	75
75	172	154.5	156	70	61	60	35	26	6	4	60	90	33	100
100	213	195.5	197	70	102	70	35	32	6	5	70	119	45	125
125	271	253.5	255	76	154	75	38	40	8	6	75	155	67	150
150	311	293.5	295	80	190	80	40	30	8	7	80	180	82	175

HLS25(With shock absorber)

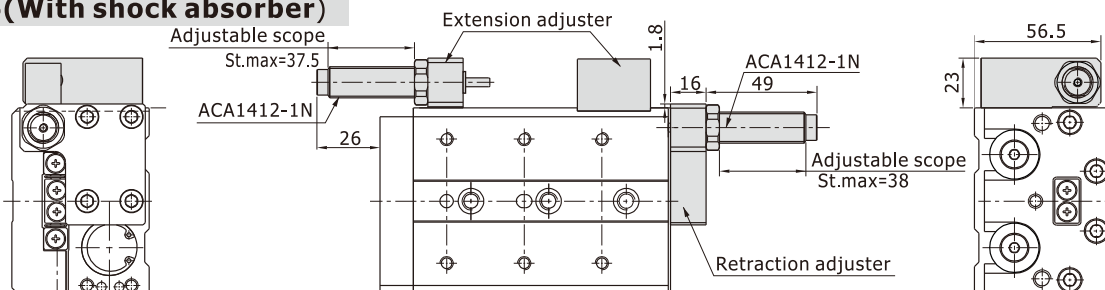

Slide tube cylinder



HLS, HLSSL Series

Cross bearing type

Bore size: $\Phi 6, \Phi 8, \Phi 12, \Phi 16, \Phi 20, \Phi 25$

HLSSL25

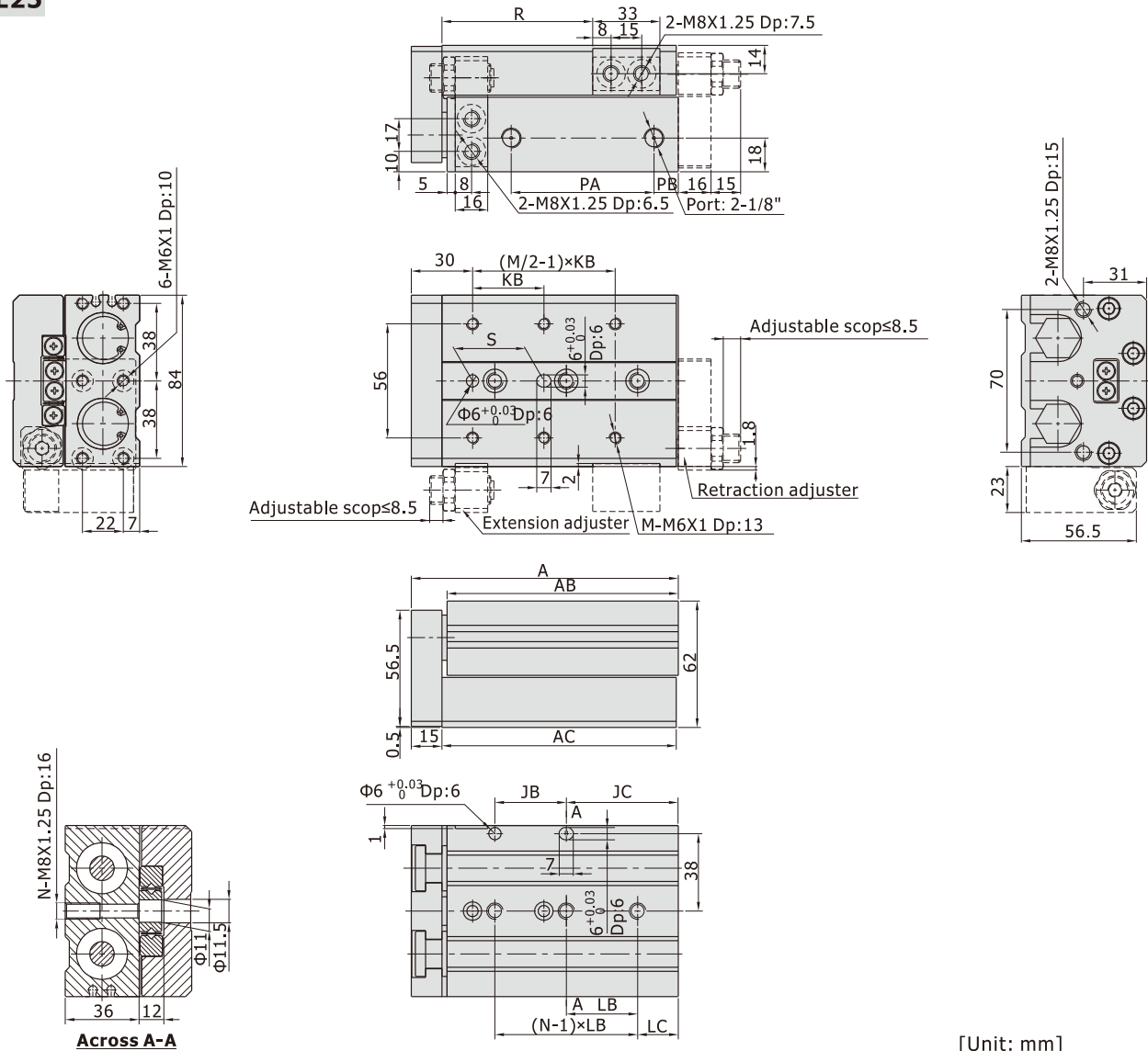

[Unit: mm]

Stroke\Item	A	AB	AC	JB	JC	KB	LB	LC	M	N	S	PA	PB	R
10	108	90.5	92	45	22	50	45	22	4	2	40	47	12	35
20	108	90.5	92	45	22	50	45	22	4	2	40	47	12	45
30	108	90.5	92	45	22	50	45	22	4	2	40	47	12	55
40	118	100.5	102	55	22	60	55	22	4	2	50	57	12	65
50	131	113.5	115	35	55	35	35	20	6	3	35	70	12	75
75	172	154.5	156	70	61	60	35	26	6	4	60	90	33	100
100	213	195.5	197	70	102	70	35	32	6	5	70	119	45	125
125	271	253.5	255	76	154	75	38	40	8	6	75	155	67	150
150	311	293.5	295	80	190	80	40	30	8	7	80	180	82	175

HLSSL25 (With shock absorber)

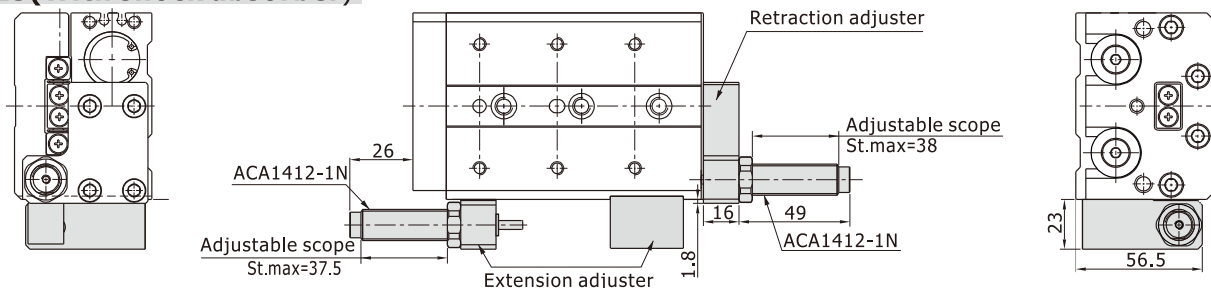

Slide tube cylinder

HLS, HLSL Series

Cross bearing type Accessories

Accessory ordering code

F - HLS 20 AF



① Accessory

② Cylinder model

HLS: Slide tube cylinder (Double acting type)
(Cross bearing type)

HLSL: Symmetrical Slide tube cylinder (Double acting type)
(Cross bearing type)

④ Accessory type [Note]

A: Adjustable rubber stopper(Both ends)

AS: Adjustable rubber stopper(Extention)

AF: Adjustable rubber stopper(Retraction)

B: Shock absorber(Both ends)

BF: Shock absorber(Retraction)

③ Bore Size

6 8 12 16 20 25

[Note]The list accessories are for HLS cylinder. Accessories that are adaptable to other cylinder are not shown. Please refer to accessory list for selection and ordering information.

Accessory selection

	Accessories\Bore size		6	8	12
	Standard (HLS)	Both ends	A(Adjustable rubber stopper)	F-HLQ6A	F-HLS8A
B(Shock absorber)			×	F-HLS8B	F-HLS12B
Extention		AS(Adjustable rubber stopper)	F-HLS6AS	F-HLS8AS	F-HLS12AS
		BS(Shock absorber)	×	F-HLQ8BS	F-HLQ12BS
Retraction		AF(Adjustable rubber stopper)	F-HLQ6AF	F-HLS8AF	F-HLS12AF
		BF(Shock absorber)	×	F-HLS8BF	F-HLS12BF
	Accessories\Bore size		16	20	25
	Standard (HLS)	Both ends	A(Adjustable rubber stopper)	F-HLS16A	F-HLS20A
B(Shock absorber)			F-HLS16B	F-HLS20B	F-HLS25B
Extention		AS(Adjustable rubber stopper)	F-HLS16AS	F-HLS20AS	F-HLS25AS
		BS(Shock absorber)	F-HLQ16BS	F-HLQ20BS	F-HLQ25BS
Retraction		AF(Adjustable rubber stopper)	F-HLS16AF	F-HLS20AF	F-HLS25AF
		BF(Shock absorber)	F-HLS16BF	F-HLS20BF	F-HLS25BF
	Accessories\Bore size		6	8	12
	Symmetrical (HLSL)	Both ends	A(Adjustable rubber stopper)	F-HLQL6A	F-HLSL8A
B(Shock absorber)			×	F-HLSL8B	F-HLSL12B
Extention		AS(Adjustable rubber stopper)	F-HLS6AS	F-HLS8AS	F-HLS12AS
		BS(Shock absorber)	×	F-HLQ8BS	F-HLQ12BS
Retraction		AF(Adjustable rubber stopper)	F-HLQL6AF	F-HLSL8AF	F-HLSL12AF
		BF(Shock absorber)	×	F-HLSL8BF	F-HLSL12BF
	Accessories\Bore size		16	20	25
	Symmetrical (HLSL)	Both ends	A(Adjustable rubber stopper)	F-HLSL16A	F-HLSL20A
B(Shock absorber)			F-HLSL16B	F-HLSL20B	F-HLSL25B
Extention		AS(Adjustable rubber stopper)	F-HLS16AS	F-HLS20AS	F-HLS25AS
		BS(Shock absorber)	F-HLQ16BS	F-HLQ20BS	F-HLQ25BS
Retraction		AF(Adjustable rubber stopper)	F-HLSL16AF	F-HLSL20AF	F-HLSL25AF
		BF(Shock absorber)	F-HLSL16BF	F-HLSL20BF	F-HLSL25BF

Note): A=AS+AF; B=BS+BF.

Slide tube cylinder

HLS, HLSSL Series

Cross bearing type Accessories

Dimensions

AS: Adjustable rubber stopper(Extension)

Body Mounting

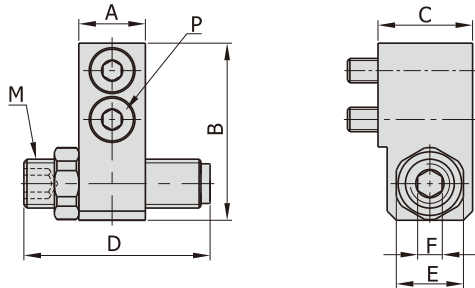
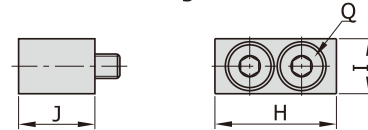

Table Mounting



[Unit: mm]

Bore size\Item	Adjusting stroke range	A	B	C	D	E	F	M	P	H	I	J	Q
6	5	7	19	10.5	16.5	8	3	M6×1.0	M2.5Length:10	12.5	6.5	10.5	M2.5Length:10
8	5	8.5	22	14	21.5	11	4	M8×1.0	M3Length:14	14.5	8	12	M3Length:14
12	5	11	29	15.5	21.5	11	4	M8×1.0	M4Length:16	20	9	13.5	M4Length:12
16	5	12	36	17.5	24	14	5	M10×1.0	M5Length:16	23	10.5	17	M5Length:16
20	5	15	44.5	22	28	17	6	M12×1.0	M6Length:20	25	12.5	21	M6Length:20
25	5	16	54	24	32	19	6	M14×1.5	M8Length:20	33	16.5	23	M8Length:20

BS: Shock absorber(Extension)

Body Mounting

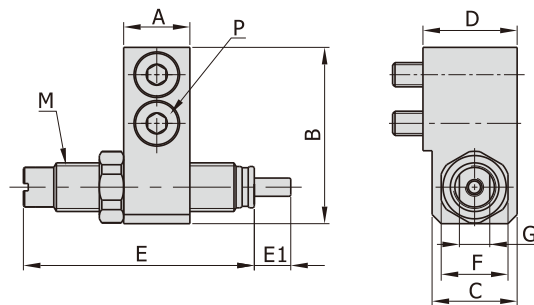
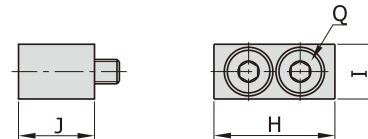

Table Mounting



[Unit: mm]

Bore size\Item	A	B	C	D	E	E1	F	G	M	P	H	I	J	Q
8	8.5	22	12.5	14	40	6	11	7	M8×1.0	M3Length:14	14.5	8	12	M3Length:14
12	11	29	14	15.5	40	6	11	7	M8×1.0	M4Length:16	20	9	13.5	M4Length:12
16	12	36	16	17.5	49	7	14	9	M10×1.0	M5Length:16	23	10.5	17	M5Length:16
20	15	44.5	20	22	53.5	10	17	11	M12×1.0	M6Length:20	25	12.5	21	M6Length:20
25	16	54	22	24	68.5	12	19	12	M14×1.5	M8Length:20	33	16.5	23	M8Length:20

AF: Adjustable rubber stopper(Retraction for standard)

[Unit: mm]

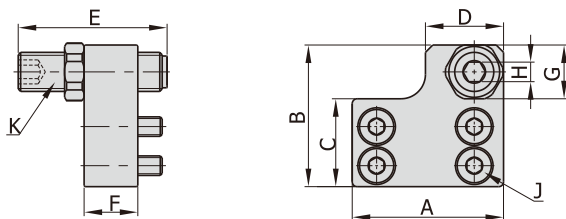

Bore size\Item	Adjusting stroke range	A	B	C	D
6	5	18	19	11	8
8	5	24	22.5	13	14
12	5	31	29	18	16
16	5	37	37.5	23	18
20	5	45.5	47	28.5	23
25	5	54	56	34	28

Bore size\Item	E	F	G	H	J	K
6	21.5	7	8	3	M2.5Length:6	M6×1.0
8	21.5	8.5	11	4	M3Length:8	M8×1.0
12	21.5	11	11	4	M4Length:12	M8×1.0
16	24	12	14	5	M5Length:12	M10×1.0
20	28	15	17	6	M5Length:16	M12×1.0
25	32	16	19	6	M6Length:18	M14×1.5

Slide tube cylinder

HLS, HLSSL Series

Cross bearing type Accessories

AF: Adjustable rubber stopper(Retraction, for symmetrical)

[Unit: mm]

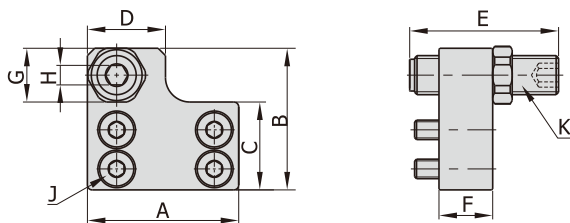

Bore size/Item	Adjusting stroke range	A	B	C	D
6	5	18	19	11	8
8	5	24	22.5	13	14
12	5	31	29	18	16
16	5	37	37.5	23	18
20	5	45.5	47	28.5	23
25	5	54	56	34	28

Bore size/Item	E	F	G	H	J	K
6	21.5	7	8	3	M2.5Length:6	M6×1.0
8	21.5	8.5	11	4	M3Length:8	M8×1.0
12	21.5	11	11	4	M4Length:12	M8×1.0
16	24	12	14	5	M5Length:12	M10×1.0
20	28	15	17	6	M5Length:16	M12×1.0
25	32	16	19	6	M6Length:18	M14×1.5

BF: Shock absorber(Retraction, for standard)

[Unit: mm]

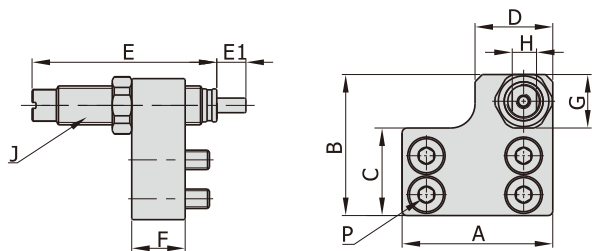

Bore size/Item	A	B	C	D	E	E1	F
8	24	22.5	13	14	40	6	8.5
12	31	29	18	16	40	6	11
16	37	37.5	23	18	49	7	12
20	45.5	47	28.5	23	53.5	10	15
25	54	56	34	28	68.5	12	16

Bore size/Item	G	H	J	P
8	11	7	M8×1.0	M3Length:8
12	11	7	M8×1.0	M4Length:12
16	14	9	M10×1.0	M5Length:12
20	17	11	M12×1.0	M5Length:16
25	19	12	M14×1.5	M6Length:18

BF: Shock absorber(Retraction, for symmetrical)

[Unit: mm]

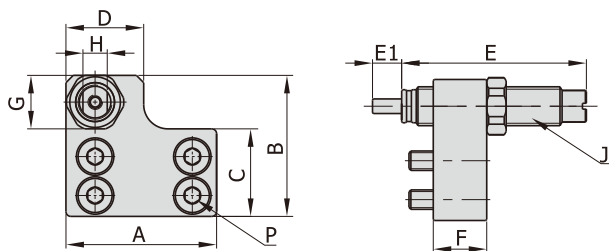

Bore size/Item	A	B	C	D	E	E1	F
8	24	22.5	13	14	40	6	8.5
12	31	29	18	16	40	6	11
16	37	37.5	23	18	49	7	12
20	45.5	47	28.5	23	53.5	10	15
25	54	56	34	28	68.5	12	16

Bore size/Item	G	H	J	P
8	11	7	M8×1.0	M3Length:8
12	11	7	M8×1.0	M4Length:12
16	14	9	M10×1.0	M5Length:12
20	17	11	M12×1.0	M5Length:16
25	19	12	M14×1.5	M6Length:18